



www.urma.ch

A close-up photograph of a precision-machined industrial tool. The tool has a series of blue, ribbed sections and black, cylindrical components. The lighting is dramatic, highlighting the metallic textures and the precision of the manufacturing.

**Innovation Is
Our Tool**

SWISS  QUALITY

URMA MX diamond



BRAND-NEW

**Präzision und Geschwindigkeit in einem:
Die neuste Generation des Planfräsens.**

Precision and speed in one:
The latest generation of face milling.

Automobil

Automotive

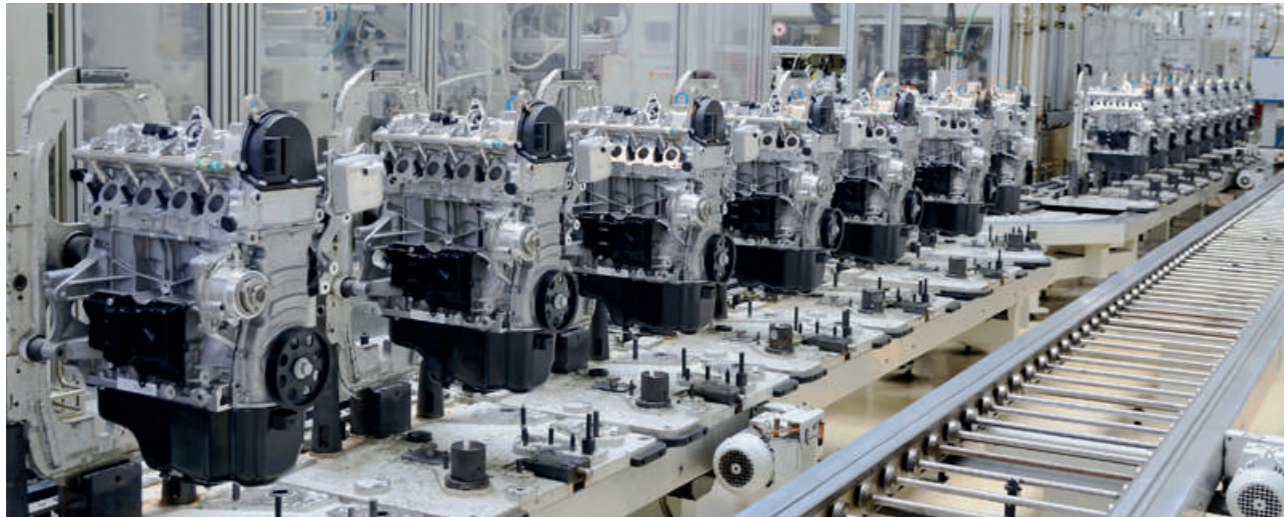

Anforderungen

- Präzision
- Prozesssicherheit
- Einfaches Handling
- Produktivität

Requirements

- Precision
- Process reliability
- Simple handling
- Productivity

Anwendungsbeispiel «Schiebergehäuse»

Material: G-AlSi7

Example of a "Slider box automatic transmission"

Material: G-AlSi7



Application Data

vc	3'500	m/min
fz	0.15	mm
z	20	
vf	26'700	mm/min
ap	1	mm
ae	110	mm
Ra	0.35	µm
Ø	125	mm

E-Mobilität

E-Mobility

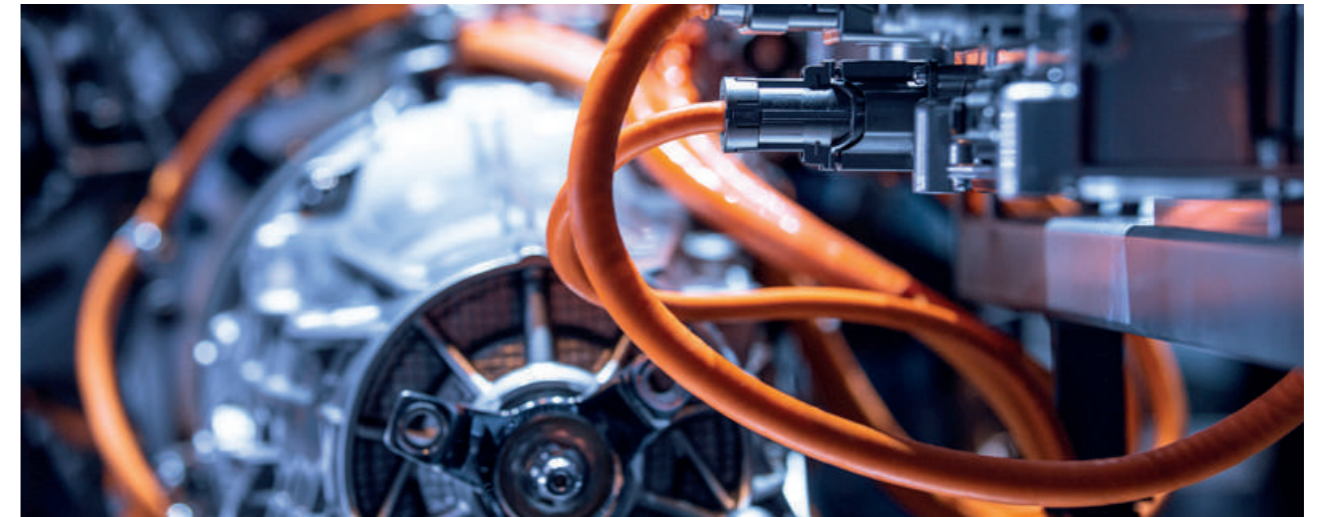

Anforderungen

- Präzision
- Prozesssicherheit
- Tiefe Kosten
- Einfaches Handling

Requirements

- Precision
- Process reliability
- Low costs
- Simple handling

Anwendungsbeispiel «Statorgehäuse E-Motor»

Material: G-AlSi9

Example of a "Electric Motor Stator Housing"

Material: G-AlSi9

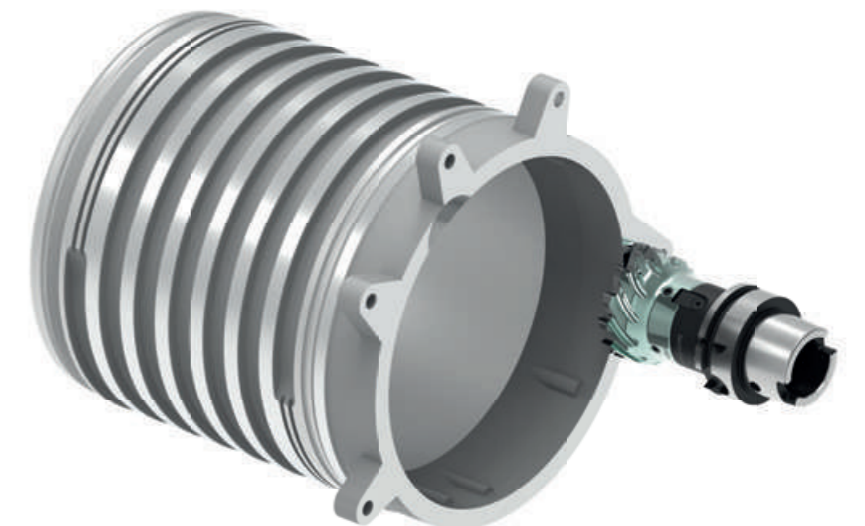

Application Data

vc	4'000	m/min
fz	0.2	mm
z	12	
vf	48'500	mm/min
ap	1	mm
ae	25-50	mm
Ra	0.4	µm
Ø	63	mm

Ihre Vorteile mit MX diamond

Your Advantages

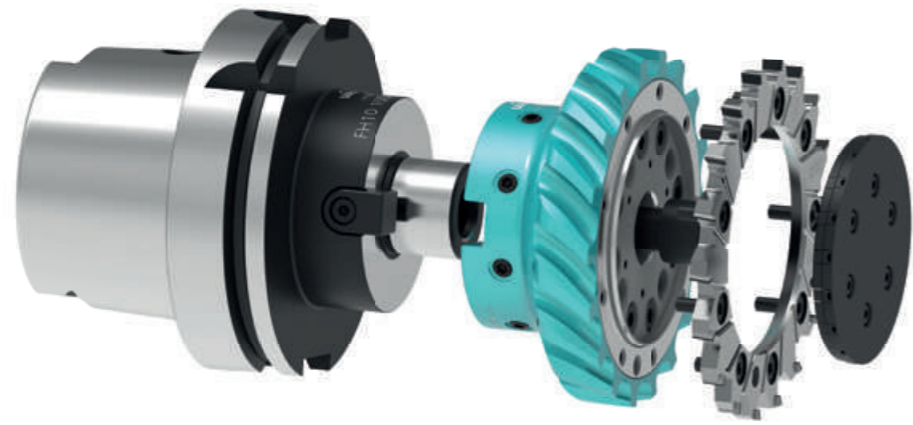

Hauptmerkmale

- Durchmesser Ø 63 mm/100 mm/125 mm
- Höchste Genauigkeit und einfachstes Handling dank bewährter RX-Technologie
- Bedeutende Einsparungen dank Hochleistungsdaten
- Höchste Steifigkeit durch PKD bestückte Vollhartmetall Frässscheibe
- Kein Einstellaufwand
- Einfache und schnelle Aufbereitung der verschlissenen Schneidringe

Key Points

- Diameter 63 mm/100 mm/125 mm
- High precision and easy handling based on the very reliable RX-technology
- Significant savings thanks to high-performance cutting
- Highest rigidity thanks to pcd tipped solid carbide cutting ring
- No adjustment efforts for the customer
- Quick and easy reconditioning of worn-out reaming heads



Motorblock aus Aluminium. Aluminium motor block. Source: URMA AG

URMA Fräsen MX diamond

URMA Milling MX diamond

Aufnahmen
Adaptors



Schneidenträger
Cutter Body



Frässhneiden
Milling Cutter



Frässhneiden

Milling Cutter

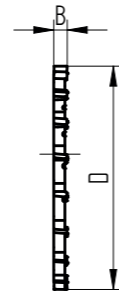

Frässhneiden

Milling Cutter

System Size	Order Number	d	B	z	kg	Geometry	Grade	Stock
MX063	MXF63 06-M01 PD06	63	6	12	0.091	M01	PD06	•
MX100	MXF100 06-M01 PD06	100	6	18	0.210	M01	PD06	•
MX125	MXF125 06-M01 PD06	125	6	20	0.398	M01	PD06	•



Schneidenträger

Cutter Body

Schneidenträger Stahl

Cutter Body Steel

System Size	Order Number	L	D	d1	d2	kg	Stock
MX063	MXK63 22 045	45	22	48	62	0.601	•

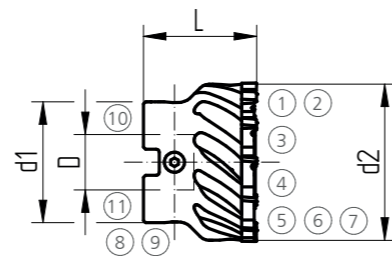

Schneidenträger Aluminium

Cutter Body Aluminium

System Size	Order Number	L	D	d1	d2	kg	Stock
MX100	MXKL100 27 050A	50	27	63	99	0.956	•
MX125	MXKL125 32 055A	55	32	78	124	1.527	•

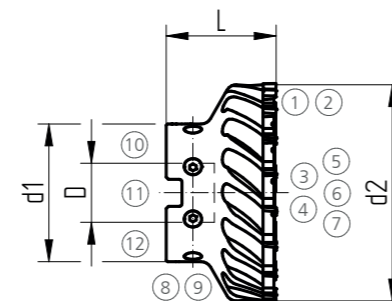

Ersatzteile Schneidenträger siehe Seite 13

Spare parts blade carrier on page 13

z Anzahl Zähne / Number of teeth • An Lager / On stock ▲ Kurzfristig lieferbar / Short-term availability ○ Verfügbarkeit auf Anfrage / Availability on request Alle Massangaben in mm / All dimensions in mm

Aufnahmen

Adaptors



DIN 69871 – AD

System Size	L	I	D	d	Order Number	Stock
SK40	55	19	22	48	FD10 40AB 22 055	•
SK40	55	21	27	60	FD10 40AB 27 055	•
SK40	60	24	32	78	FD10 40AB 32 060	•
SK50	55	19	22	48	FD10 50AB 22 055	•
SK50	55	21	27	60	FD10 50AB 27 055	•
SK50	55	24	32	78	FD10 50AB 27 055	•

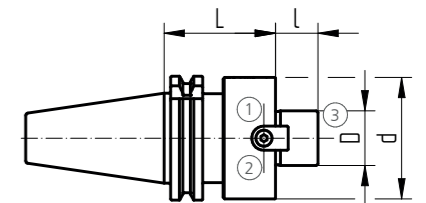

MAS-BT JIS 6339 – AD

System Size	L	I	D	d	Order Number	Stock
BT40 - Ø22	55	19	22	48	FT10 40AB 22 055	•
BT40 - Ø27	55	21	27	60	FT10 40AB 27 055	•
BT40 - Ø32	60	24	32	78	FT10 40AB 32 060	•
BT50 - Ø22	55	19	22	48	FT10 50AB 22 055	•
BT50 - Ø27	55	21	27	60	FT10 50AB 27 055	•
BT50 - Ø32	55	24	32	78	FT10 50AB 32 055	•

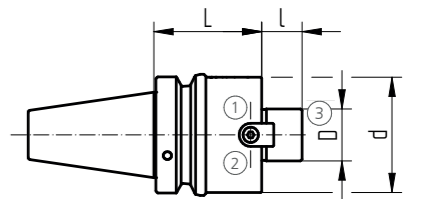

DIN 26623-1-PSC

System Size	L	I	D	d	Order Number	Stock
PSC 60	50	19	22	48	FC10 63 22 050	•
PSC 60	60	21	27	60	FC10 63 27 060	•
PSC 60	60	24	32	78	FC10 63 32 060	•

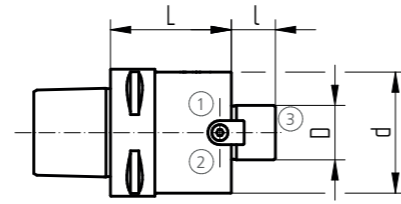

DIN 69893 HSK-A

System Size	L	I	D	d	Order Number	Stock
HSK63	50	19	22	48	FH10 63A 22 050	•
HSK63	60	21	27	60	FH10 63A 27 060	•
HSK63	60	24	32	78	FH10 63A 32 060	•
HSK100	50	19	22	48	FH10 100A 22 050	•
HSK100	50	21	27	60	FH10 100A 27 050	•
HSK100	50	24	32	78	FH10 100A 32 050	•

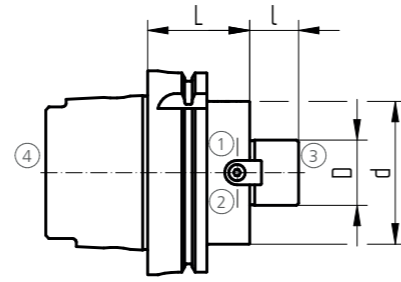

Ersatzteile
Spare Parts

D	①	②	③
22	Z00 70 22	C00 22 05	C00 24 08
27	Z00 70 27	C00 22 07	C00 24 04
32	Z00 70 32	C00 24 05	C00 24 09

Kühlmittelrohr
Coolant Tube

Size	④
63	H00 63 01
100	H00 100 01

Zubehör

Accessories

Drehmomentdreher
Screw Driver

System Size	Dimension	Torque	Order Number	Stock
MX 063	T10	3,5 Nm	G00 40 18	▲
MX 100	T15	3,5 Nm	G00 40 13	▲
MX 125	T15	3,5 Nm	G00 40 13	▲



Sechskant-Steckeinsatz
Hex Bit Socket

System Size	Dimension	Torque	Order Number	Stock
MX 063 - MX 125	SW8 / SW10 / SW14	40 - 200 Nm	G00 40 40	▲
MX 063	SW8	80 Nm	G00 40 44	▲
MX 100	SW10	85 Nm	G00 40 43	▲
MX 125	SW14	160 Nm	G00 40 42	▲



Messmittel
Measuring Device

Type	Description	Order Number	Stock
Twin T10	Elektronisches Messgerät, inklusive Batterien Electronic measuring instrument, batteries incl.	04430013	○
LRC 6, AA	Batterien (3 Stück) Batteries (3 pieces)	04768002	○
GT 31	Hebelmesstaster Lever probe	03210802	○
MGA	Magnetischer Gelenkarm Magnetic articulated arm	01639022	○



Ersatzteile Schneidenträger
Spare Parts Cutter Body

System Size	①	②	③	④	⑤
MX063	C00 70 04	G00 20 07	C00 22 64	G00 02 08	Z90 15 06
MX100	C00 70 05	G00 20 03	C00 70 06	G00 02 09	Z90 15 10
MX125	C00 70 05	G00 20 03	C00 70 07	G00 02 16	Z90 15 12

System Size	⑥	⑦	⑧	⑨	⑩	⑪	⑫
MX063	C00 22 30	G00 02 03	C00 25 03	G00 02 04	ZA00 90 14	C00 70 01	G00 02 25
MX100	C00 22 30	G00 02 03	C00 25 04	G00 02 04	ZA00 90 13	C00 70 02	G00 02 26
MX125	C00 22 56	G00 02 03	C00 25 04	G00 02 04	ZA00 90 07	C00 70 03	G00 02 27

Ersteinstellung Initial Setup

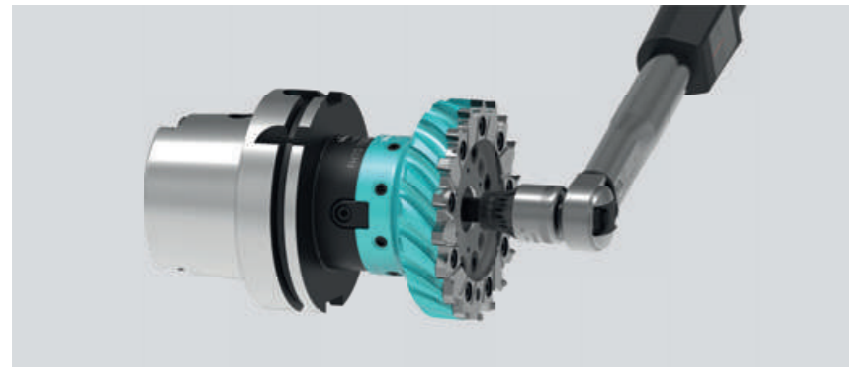

- 1** Werkzeug zusammenbauen.
Assemble the tool.

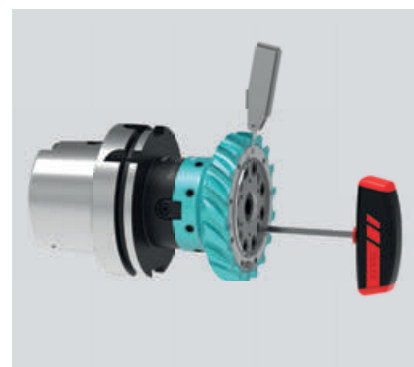

- 2** Planlauf einstellen.
Run-out adjustment.

- Trennstelle reinigen.**
Clean the interface.

3



- 4** Schneide montieren.
Assemble new cutting ring.

- Kühlmittelscheibe montieren.**
Assemble the coolant disk.

5

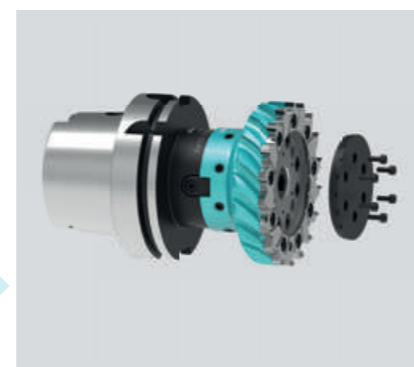

- 6** Bauteil bearbeiten.
Machining the component.

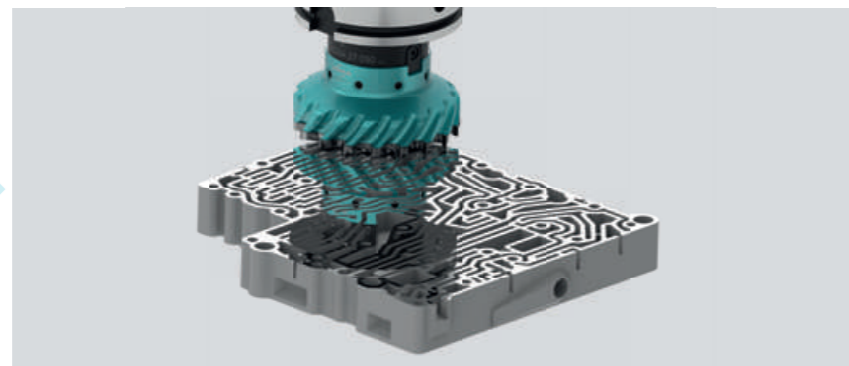

Frässhneiden-Wechsel Changing Cutting Ring

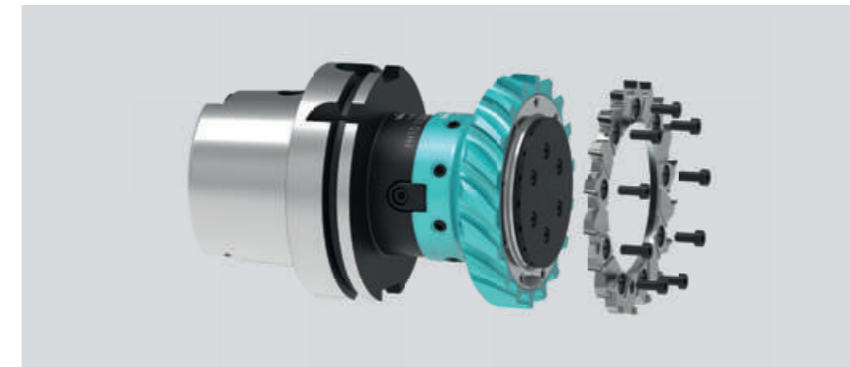

- 1** Frässhneide demontieren.
Remove the cutting ring.



- 2** Trennstelle reinigen.
Clean the interface.

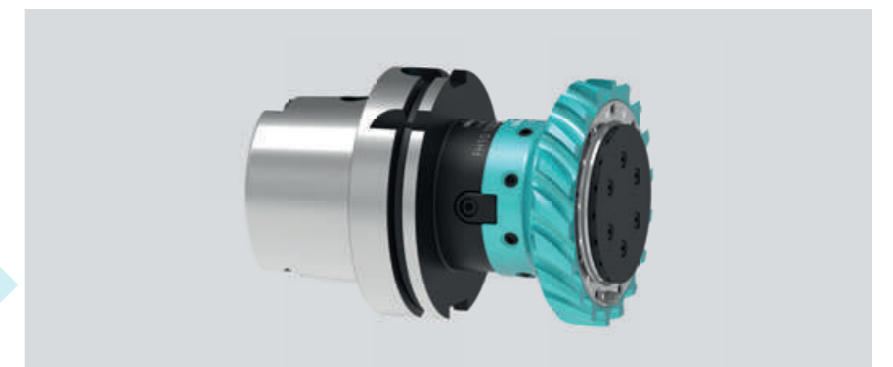

- 3** Frässhneide montieren.
Assemble new cutting ring.

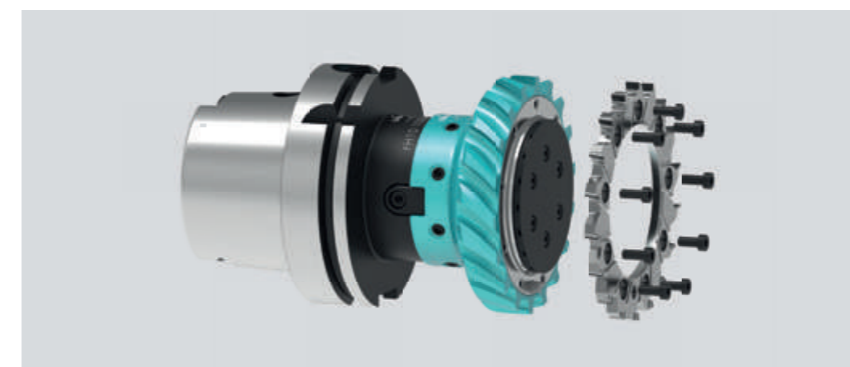

- 4** Bauteil bearbeiten.
Machining the component.

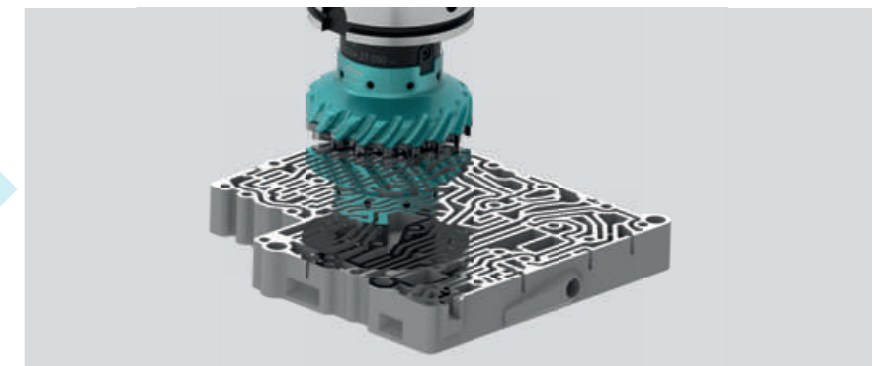

Schnittdaten

Cutting Data

ISO	UMC	Grade	VC	fz
N	N1	PD06	2000-3500-5000	0.05-0.15-0.3
	N2			
	N3			
	N4	PD06	1500-2500-3500	0.05-0.15-0.3
	N5			
	N6	PD06	1000-1800-2500	0.05-0.15-0.3
O	O1	PD06	500-800-1000	0.05-0.15-0.3
	O2			
	O3	PD06	300-600-800	0.05-0.15-0.3
	O4			

ISO	UMC	Bezeichnung	Description	Rm [N/mm ²]	HB	Kc1.1	mc	DIN Nr.	Example
N	N1	Aluminium Knetlegierungen mit Si < 2%	Aluminum wrought alloy with Si < 2%	< 300	< 150	600	0.23	3.3535	AlMg3
	N2	Aluminiumlegierungen mit Si < 7%	Aluminum alloys, Si < 7%	< 400	< 120	700	0.25	3.2152	AlSi6Cu4
	N3	Aluminiumlegierungen mit Si > 8% < 15% und Magnesiumlegierungen	Aluminum alloys 8% < Si < 15% and alloys Magnesium	< 400	< 120	700	0.25	3.2163 3.2581	AlSi9Cu3 AlSi12
	N4	Aluminiumlegierungen mit Si > 15%	Aluminum alloys, Si > 15%	> 400	> 120	800	0.25		AlSi17Cu4Mg
	N5	Kupferlegierungen gut zerspanbar	Copper alloys, good machinability	< 700	< 210	800	0.2	2.0401 2.1090	CuZn39Pb3 CuSn7Zn4Pb7-C
	N6	Kupferlegierungen schwieriger zerspanbar	Copper alloys, more difficult machinability	> 500	> 150	1100	0.25	2.0966	CuAl10Ni5Fe4

Kunst- und Verbundwerkstoffe

Composite Materials

ISO	UMC	Bezeichnung	Description	Rm [N/mm ²]	HB	Kc1.1	mc	DIN Nr.	Example
O	O1	Thermoplastische Kunststoffe	Thermoplastic polymers			150	0.26		Polyamid 6 (PA 6) Polyoxymethylen (POM)
	O2	Duroplastische Kunststoffe	Thermosetting plastics			150	0.26		Epoxyharze (EP)
	O3	Kunststoffe mit < 50% Glas	Reinforced plastics with < 50% glass fibers			300	0.26		Polyamid 6 mit 30% GF (PA 6 GF 30)
	O4	Glas-, Kohlen-, Aramidfaser-verstärkte Kunststoffe	Glass fiber-, carbon fiber- and aramid reinforced plastics			300	0.26		GFK CFK

Maximale Drehzahl

Maximum Revolution

System Size	D	max. Vc	max. rpm
MX063	63	4948 m/min	25000 1/min
MX100	100	4712 m/min	15000 1/min
MX125	125	4712 m/min	12000 1/min

Drehmoment-/Leistungsbedarf

Torque And Power Requirements

Fräuscheibe Ø63

Cutting Ring Ø63

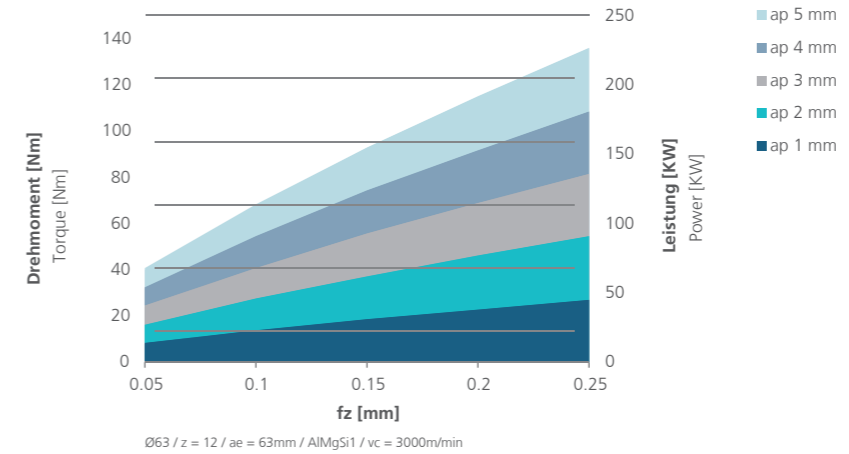

Fräuscheibe Ø100

Cutting Ring Ø100

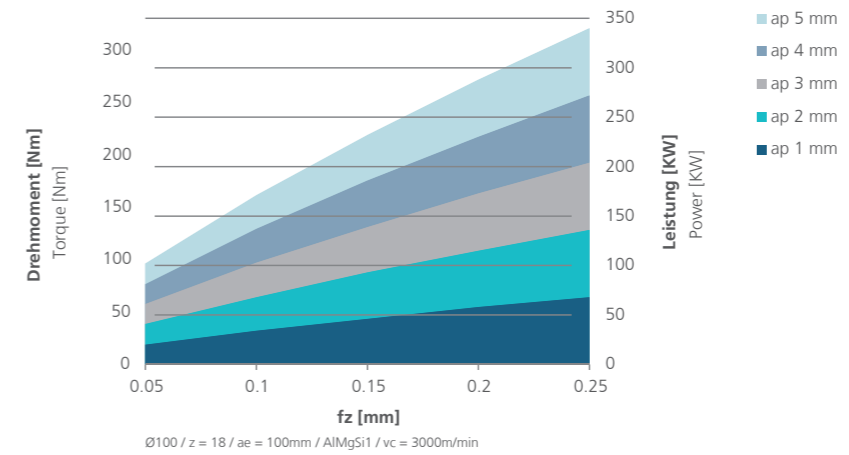

Fräuscheibe Ø125

Cutting Ring Ø125

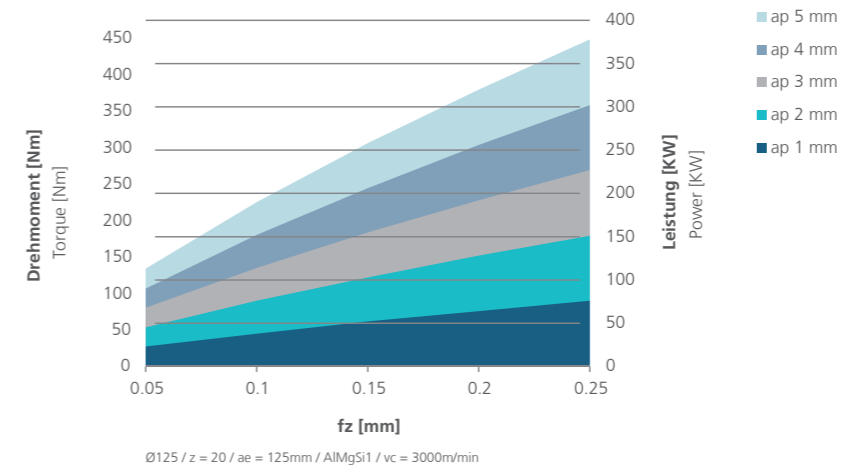

Bearbeitungsstudie Machining Study

MAIL TO customerservice@urma.ch

Absender * Sender		Number	
Firma Company		URMA Vertretung URMA Distributor	
Adresse Address		Sachbearbeiter Contact	
Maschine Machine			
Typ und Hersteller Machine Type			
Horizontal * Horizontal <input type="checkbox"/>		Vertikal * Vertical <input type="checkbox"/>	
Spindelaufnahme * Spindle Holder		Grösse * Size	
DIN 69893-HSK <input type="checkbox"/>		20 <input type="checkbox"/>	25 <input type="checkbox"/>
DIN 69871 <input type="checkbox"/>		30 <input type="checkbox"/>	32 <input type="checkbox"/>
MAS-BT <input type="checkbox"/>		40 <input type="checkbox"/>	50 <input type="checkbox"/>
Zylinderschaft DIN 1835 <input type="checkbox"/> Cylinder Shank DIN 1835		63 <input type="checkbox"/>	80 <input type="checkbox"/>
DIN 69880 VDI <input type="checkbox"/>		100 <input type="checkbox"/> <input type="checkbox"/>
..... <input type="checkbox"/>			
Kühlung Lubricant			
Öl * Oil <input type="checkbox"/>	MMS * 1) MLS 1) <input type="checkbox"/>	Emulsion * Emulsion <input type="checkbox"/>	Mischungsverhältnis (in %) Ratio of Mixture (in %)
Innere Kühlmittelzufuhr * Intern. Coolant Supply <input type="checkbox"/>			Kühlmitteldruck (bar)* Coolant Pressure (bar)
Werkstück Workpiece			
Bezeichnung Designation	Werkstoffnummer * Material Number	Behandlungszustand (Härte) * Treatment Condition (Hardness)	
Bearbeitungsanforderungen Machining Requirements			
Toleranz * Tolerance	Störkonturen Interfering contours	Vorbearbeitungsart * Method of Pre-Machining	
minimale Auskraglänge Minimum Tool Length (OAL)	<input type="checkbox"/> // <input type="checkbox"/>	Sacklochbohrung * Blind Hole	
Oberflächengüte (µm) * Surface Quality (µm)	— <input type="checkbox"/> <input type="checkbox"/>	Yes <input type="checkbox"/> No <input type="checkbox"/>	
Datum * Date	R _a <input type="checkbox"/> R _z <input type="checkbox"/> R _t <input type="checkbox"/>	Jährliche Produktion: Annual Production:	
Bemerkungen Notes	Dringlichkeit: Urgency:		

* **Pflichtfelder**
Mandatory fields

1) **Mindermengen Schmierung**
Minimal lubrication system (mist coolant)

Beilage: Ihre Bearbeitungsskizze *
Attachment: Your Application Sketch

URMA Tools

Milling, Drilling, Boring & Reaming

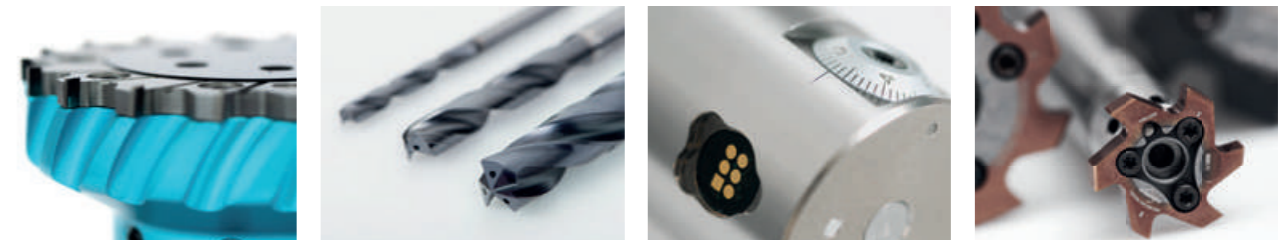



URMA WERKZEUGFABRIK

Obermatt 3
CH-5102 Rapperswil
Switzerland
T +41 62 889 20 20
F +41 62 889 20 28
info@urma.ch
www.urma.ch

Subsidiaries

URMA GmbH
Bertha-Benz-Strasse 7
D-76532 Baden-Baden
Germany
+49 7221 9969 250
info@urma-gmbh.de

URMA Trading (Shanghai) Co. Ltd.
Room 511, Hua Nan Mansion
1988 Dongfang Road
Pudong New District
CN-200125 Shanghai
+86 (21) 6109 6216
info@urmachina.com

Iraupen URMA
Poligono Belartza
ES-20018 Donostia-San Sebastian
Spain
+34 943 667 036
info@iraupen.es

URMA USA, Inc.
215 Camellia Street
Franklin, TN 37064
USA
info@urmausa.com

License Manufacturer

Command Tooling Systems, LLC
13931 Sunfish Lake Blvd.
Ramsey MN, 55303
USA
+1 800 328 2197
support@commandtool.com

Paul Horn GmbH
Horn-Straße 1
D-72072 Tübingen
Germany
+49 (0) 7071 7004 0
info@phorn.de

Sumitomo Electric Ind., Ltd.
1-1-1, Koyakita,
Itami-shi, Hyogo 664-0016
Japan
+81 72 772 4535
info@sumitomotool.com